

INSTALLATION MANUAL

Weiser Protect



AKOTEC
SOLARTHERMIE

Technology and Nature in Harmony



AKOTEC
SOLAR THERMIE

INSTALLATION MANUAL WEISER PROTECT

1	Notes	pages 4 - 5
2	Technical data	pages 6 - 7
3	Installation	pages 8 - 13
4	Interconnection	pages 14 - 15
5	Checklist	pages 16 - 18

1

Notes

Please also refer to the planning and commissioning instructions and the data sheet. Both can be downloaded from our website.

<https://www.akotec.eu/english/downloads/>

Safety in general:

Installation may only be carried out by qualified personnel in accordance with the applicable regulations and standards. Improper installation can lead to damage to the collectors and the entire system.

In addition to these important applicable standards, the national installation regulations, legal regulations for accident prevention, environmental protection and the professional associations must be observed, as well as the relevant safety regulations of DIN, EN, DVGW and VDE.

DIN EN 1991-1-4 and DIN EN 1991-1-3	Fundamentals of structural design and effects on supporting structures-snow loads and wind loads
DIN EN 62305-3 and DIN VDE 0185	Grounding and lightning protection
EnEV	Insulation of pipelines

Transport and storage

- store tubes and collectors in a dry place until installation and store them in their packaging to protect them from damage.
The surface must be level.
- do not load the tube and collector cartons from above, except for identical cartons. Stack a maximum of 7 tube cartons on top of each other.
- transport and store tubes and collectors horizontally, paying attention to the top and bottom.
- handle full-vacuum tubes carefully and only touch them with cotton gloves.

Warning signs and Signal color

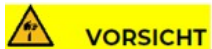

Accident risk

Measure to prevent an accident

from serious injury or death due to falls from heights and from working on ladders

use PPE

ensure ambidextrous working

do not work alone

of head injuries or death from falling objects.

wear safety helmet

secure objects from falling

from burns caused by hot surfaces on all parts of the collector or by hot steam.

avoid skin contact

touch only with protective gloves

work on the system only when the system is cold or in low-radiation weather

do not store vacuum tubes in the sun

do not switch off the system when it is exposed to sunlight

from injuries caused by working with machine tools

follow the operating instructions

use PPE

from cuts caused by broken glass from broken full vacuum tubes

handle with care

work with protective gloves

Warranty:

The statutory warranty claims apply. Furthermore, you have the possibility to extend the warranty to 20 years. To do this, register your system at

<https://www.akotec.eu/english/infos/garantie/>

Please also note the current warranty conditions at

<https://www.akotec.eu/english/downloads>

Occupational health and safety:

- wear helmet, hearing protection and safety glasses
- create fall protection
- handle glass tubes with gloves only

Tools:

- drilling machine
- measuring tape (folding rule)
- spirit level
- open-end wrench SW 13
- socket wrench SW 13
- hammer
- angle grinder



Mounting types:

- pitched roof
- flat roof (with elevation)
- free standing
- facade (with angled base)

Important:

Please note that the collector must be mounted in vertical tube position with the collector box facing upwards. The collectors can be mounted at an angle of 10°- 80°. To protect the collector from snow, we recommend mounting a snow guard located above the collector box.

2

Technical data

Dimensions of the Weiser Protect collectors

collector	length (mm)	width (mm)	weight excl. reflector (kg)	weight incl. reflector (kg)	gross area (m ²)
with 10 hp tubes	2159	745	27,9	33,6	1,61
with 20 hp tubes	2159	1495	51,8	64,0	3,23
with 30 hp tubes	2159	2245	75,7	94,4	4,85

Mounting dimensions of Weiser Protect collectors

collector	A	B	C	D	E	F	G	H
10 tubes	745	72,5	147,5	222,5	300	450	600	1945
20 tubes	1495	297,5	372,5	447,5	600	750	900	1945
30 tubes	2452	447,5	522,5	597,5	1050	1200	1350	1945
<p>The slotted holes allow deviations of + / - 30 mm. Note: Dimensions are exclusive of end caps.</p>								

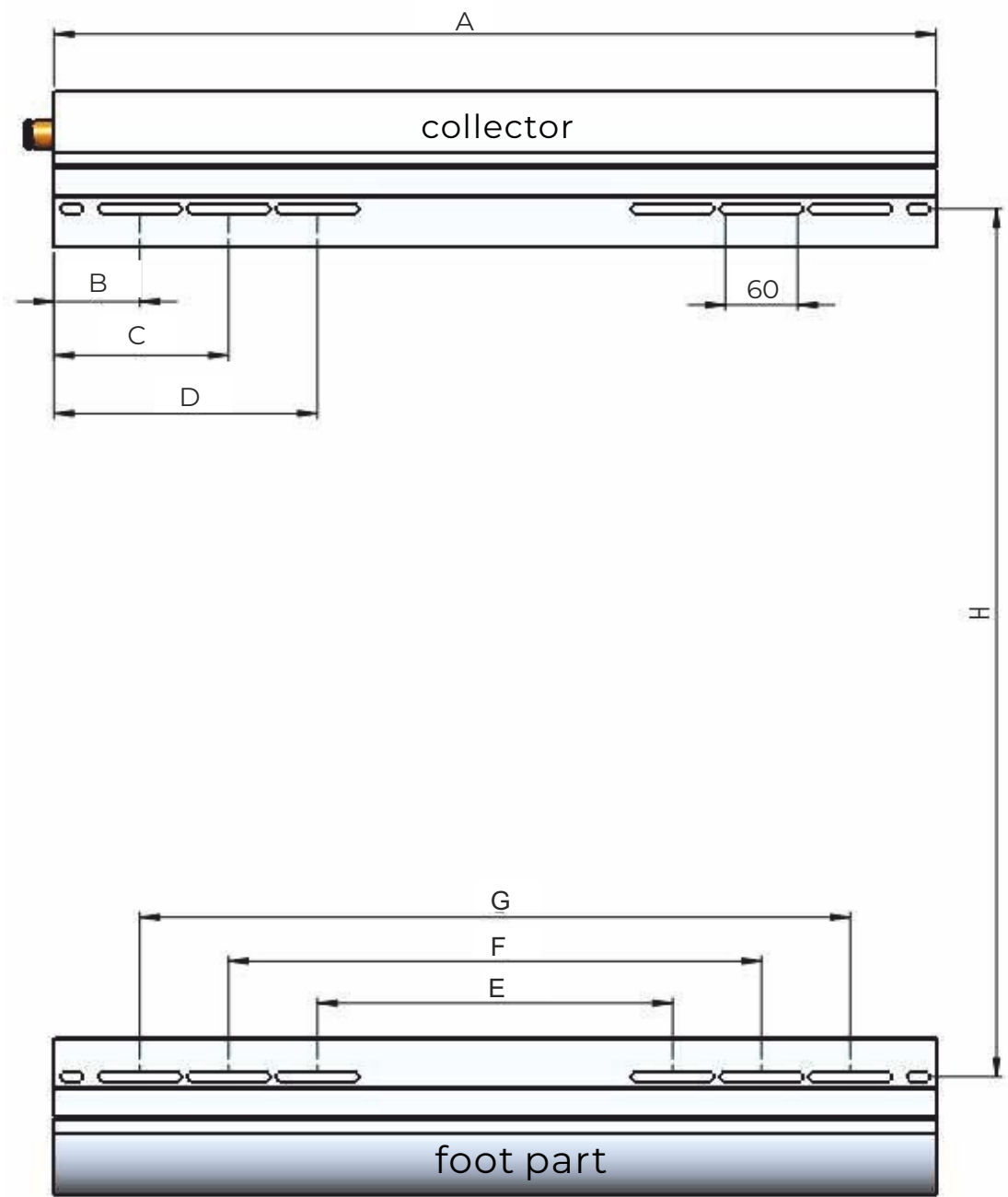

1945 mm up to 1961,5 mm

3

Installation

For all mounting types

Please also observe the corresponding mounting instructions of the mounting system.

Mounting the collector

- fasten collector with washer / nut
- align and tighten the nuts
- please make sure that the housing does not lie completely on top, otherwise the housing cover cannot be removed

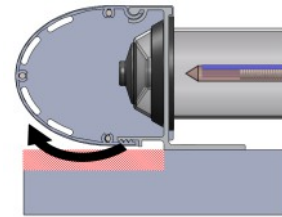

Mounting the foot part

- fasten foot part with washer and nuts
- align and tighten the nuts
- assemble collector / foot part in one alignment
- use a spirit level



Disassembly of the cover of the foot part

- press down the cover (on the side of the tootinging)
- then turn out the top
- put the lid aside



Mounting the vacuum tubes

- put on gloves (cotton)
- spray the pipe penetration and the lower part of the tube with a washing-up liquid mixture
- mount tube into the foot part with a slight turning movement

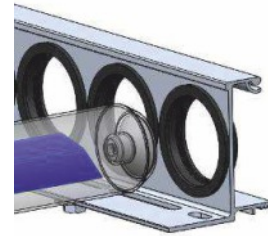

- insert the vacuum tube into the receptacles provided in the collector while rotating it.
- insert the tube into the collector / sleeve until the tube protection rubber is in contact and pull it back approx. 5 mm from the collector.
- check the tight fit of the tube by gently pulling of the tube

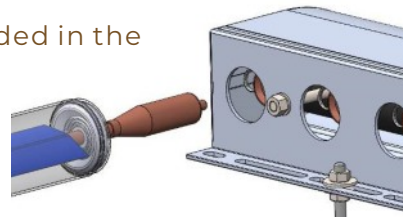

- all tubes must sit in one line in the collector

Hint:

To prevent overheating during installation of the system, do not insert the vacuum tubes until the very end, after filling and the pressure and leakage test.

For roofs with southward deviation or perpendicular mounting, turn absorber towards the sun.

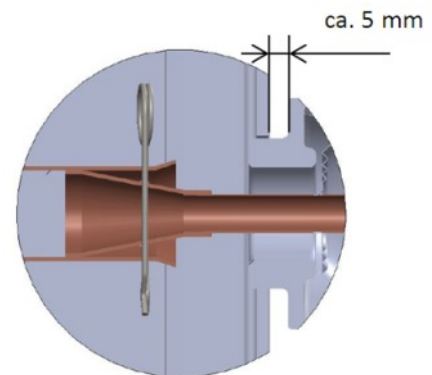

Mounting the foot section cover

- mount the cover of the foot part again
- put on the lid and turn it downwards until the lid audibly clicks into place

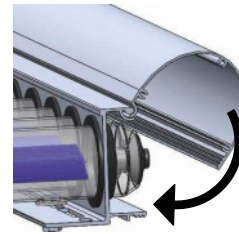

Mounting the foot section side cover

- mount the left and right side covers to the base using the screws provided

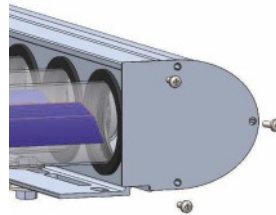

Mounting of the connection (rigid piping or corrugated hose)

- mount rigid piping on collector inlet side with slight rotating movement
- then mount the split side cover

- on the collector outlet side, mount the collector connector with immersion sleeve with a slight rotating movement.
- finally mount the split side cover

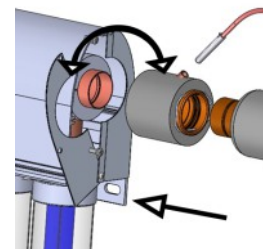
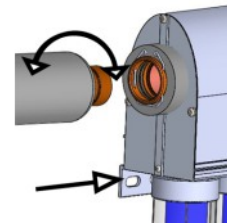

Important constant testing

- whether spring clips are seated correctly
- the entire locking system

Attention

The fixed point of the pipeline should be determined when using rigid piping so that sufficient expansion of the collector header pipe is possible. The rigid piping must NOT be shortened. The continuing connections must be supported after a length of max. 15 cm.

Notes on the continuing pipeline

Do not solder on the collector and the supplied terminals. The design of the collector must not be changed.

For installation, use only components that are suitable for the high temperatures that occur, for example, gunmetal and brass fittings, copper and stainless steel pipe. When using hemp, use only pressure and temperature resistant solar sealant.

When using compression fittings, all tube ends must be square and deburred. Push the union nut and the clamping ring onto the tube and wet the threads with a little oil. Push the tube as far as it will go into the compression fitting. First tighten the union nut by hand and then tighten by $\frac{3}{4}$ turn.

Mounting the sensor

- insert the sensor into the sensor immersion sleeve
- connect with heat shrink tubing
- shrink the shrink tubing with a heat source or wrap it with the protective film provided

Line up collectors & Connecting the collectors

- first align a collector
- mount, then tighten fastening screws
- attach the following collector with the HP collector connector to the mounted collector
- couple with slight twisting movements and light pressure
- check the locking by pulling lightly
- it maybe necessary to couple the respective following collector turned 90° upwards and then swivel it into position

Important:

Collectors must be mounted in alignment with each other, otherwise leaks may occur.

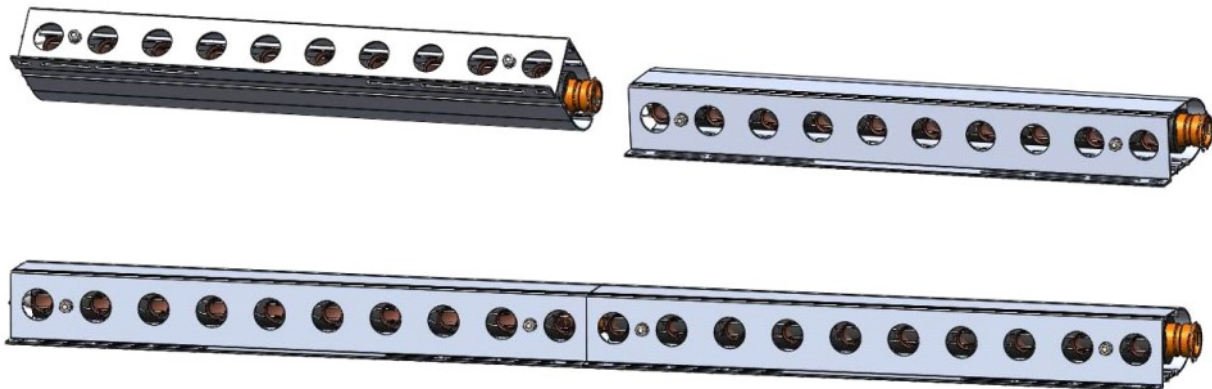

Mounting the housing connectors

- mount the housing connector using the locknuts and tighten them firmly

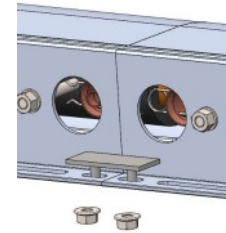

Flat roof installation

see installation instructions for collector mountings - free-standing (Art. no. 20070), free standing 10° (art. no. 20275)

Facade installation

see installation instructions for collector attachments - attachment set for facade (art. no. 20285)

Pitched roof installation

see installation instructions for collector attachments - on-roof tile (art. no. 20084), on-roof slate (art. no. 20200)

Observe the angle of the collectors

For a system for domestic water heating, we recommend the absorber align 45° to the sun. With the combination of service water heating & heating we recommend aligning the absorber at 60° to the sun.

Observe the operating pressure

The operating pressure (min. operating pressure) of the system P should be set in the cold state (20°C) so that a pressure of 1.5 bar results at the level of the collectors (headers).

Example:

The collector was installed at a height of 10 m above the membrane expansion vessel (MAG). expansion vessel (MAG). $P = (h \times 0.1) + 1.5 \text{ bar}$, $P = (10 \times 0.1) + 1.5 \text{ bar}$ corresponds to $P = 2.5 \text{ bar}$. The inlet pressure of the MAG should be set 0.3 - 0.5 below the system pressure P in the depressurized state.

This is only a rough guide. Please use the easy system planner for the design, which you can download at www.akotec.eu.

4

Interconnections

Collector circuits hp collectors

Note: Always install the sensor on the flow side!

Connection options:

One collector

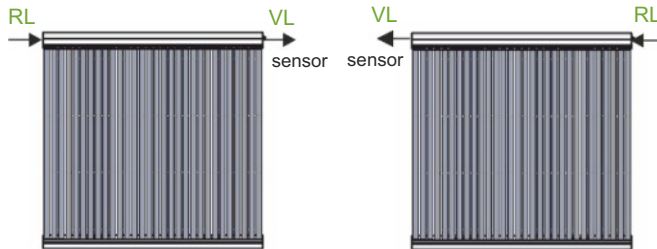

Multiple horizontal collectors in series (max. 90 tubes)

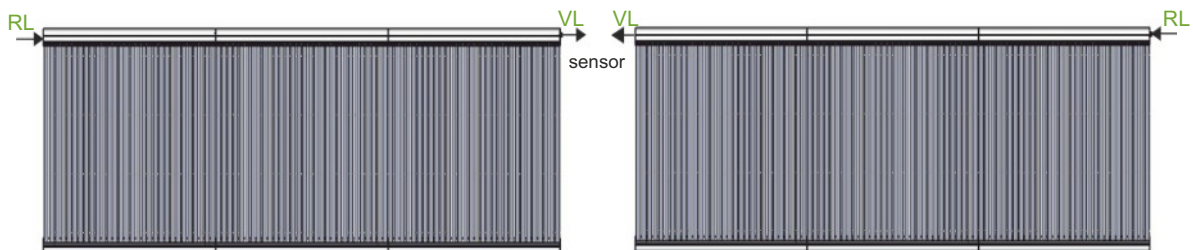

Multiple horizontal collectors in series and parallel (max. 90 tubes)

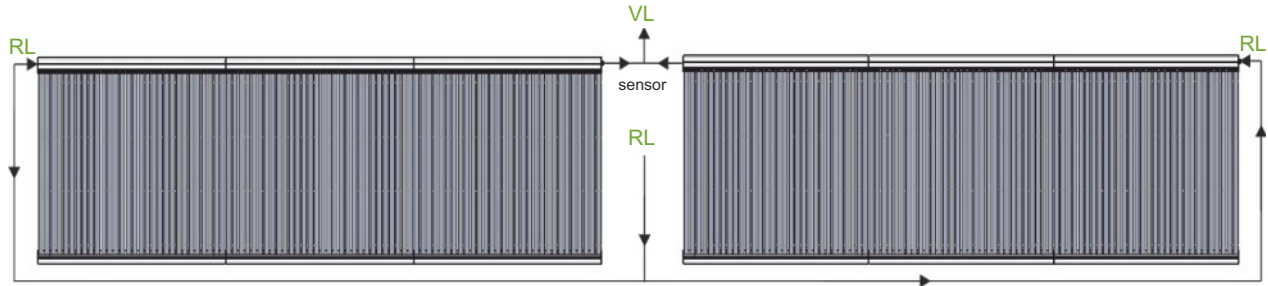

Multiple vertical collectors in series and parallel (max. 90 tubes)

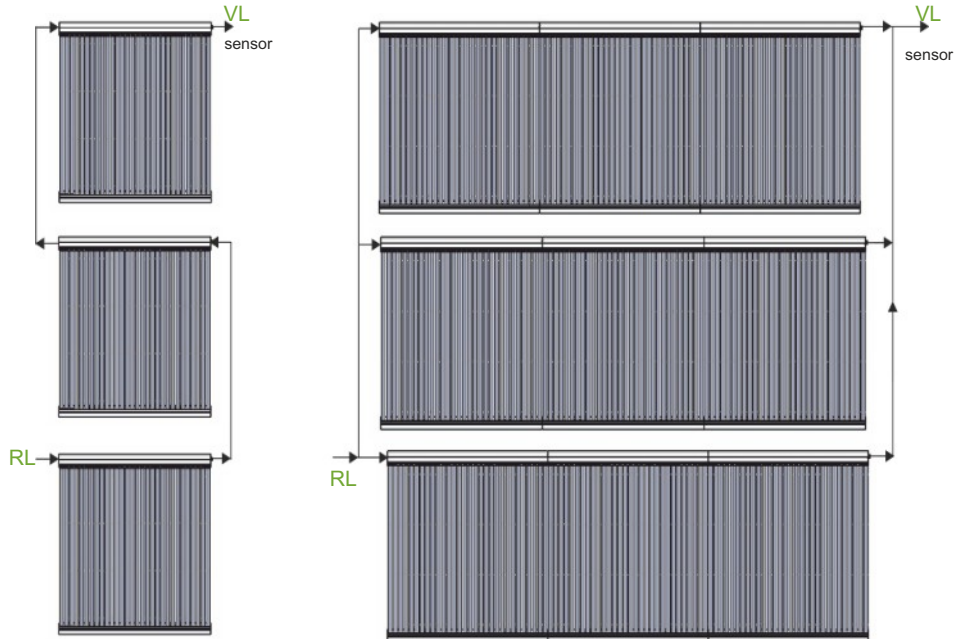

Hint:

When connecting collector areas in parallel, ensure that the partial fields are of equal size (number of vacuum tubes) and that the connection is "clean" according to Tichelmann.

5

Checklist

Important points in the overview, which are to be considered absolutely

1. Insert the vacuum tube into the collector with a rotary motion

- Spraying the tubes with a mixture of washing-up liquid and water makes tube assembly easier.
- Check locking by pulling lightly.
- Wear cotton gloves!

2. Attention. Do not use automatic air vents for a solar system!

- common error, because it is common in a standard heating system.
- Automatic air vents can be destroyed by high temperatures. Heat transfer fluid escapes, frost protection is not guaranteed.
- Functionality of the system no longer guaranteed. Use air pots with manual bleed screw.

3. Filling the system

- The heat transfer fluid must be filled with an electric flushing pump/solar filling station. It is essential to observe a minimum flushing time of 30 minutes so that the heat transfer fluid no longer contains any air pockets.
- The filling quantity depends on the number of installed collectors and the pipe lengths. Filling quantity values, see under point 4.

4. Setting the solar station

- set the solar station to a sufficient heat transfer fluid flow rate. The adjusted volume flow must be set in the DeltaSol SLL controller (ltr./h).

number of tubes	20	30	40	50	60	80	100	120	140
Heat transfer fluid Volume flow in l/min	2	3	4	5	6	8	10	12	14

Note

We expressly point out that the VT51 ready-to-use heat transfer fluid or a heat transfer fluid tested by us must be used in order to ensure long-term safe operation.

5. Expansion tank - dimensioning

- for the correct dimensioning of the expansion vessel we recommend our easy system planner (akotec.eu/english/easy-system-planner).

6. Storage

- should be dimensioned between 50 l/m² and 70 l/m² gross collector area.

7. Controller

- if no AKOTEC controller is used: the alternatively selected solar controller must have a vacuum tube collector function

8. Insulation

- complete and sufficient insulation of the solar lines is mandatory

9. Lightning strike

The collector array must be grounded against lightning in accordance with applicable grounded in accordance with applicable regulations.

10. Air pot

The air pot must always be mounted at the highest point as well as at the flow.

Maintenance instructions

The antifreeze content of the heat transfer fluid & the safety devices (safety valve and MAG) must be checked annually! A regular function check of the control and the electrical components is required!

Note for the Weiser Protect 800, 1600 and 2400

The Weiser Protect without reflector also has absorbing vacuum tubes on the back. The yield of the collectors can be increased by a reflective background on site, e.g. a light-colored wall or reflective roofing. reflective roofing, the yield of the collectors can be increased.

THE SUPERPOWER OF NATURE



AKOTEC
SOLARTHERMIE

WE ARE VERY GLAD TO BE THERE FOR YOU PERSONALLY.



AKOTEC
S O L A R T H E R M I E

■ AKOTEC Produktionsgesellschaft mbH | Grundmühlenweg 3 | D - 16278 Angermünde

■ T: +49 (0) 3331 25 716 30 | F: +49 (0) 3331 25 599 96 | M: info@akotec.eu | W: akotec.eu